

MZN1

Magnetic cylinder sensor

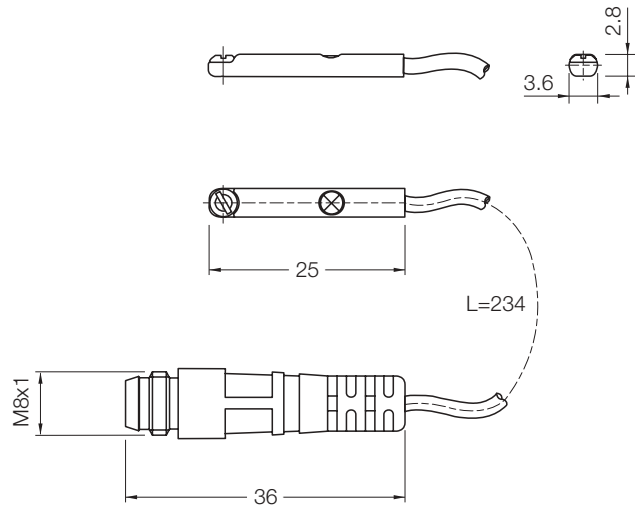

Features



- ▶ Non-contact detection of piston position in pneumatic cylinders
- ▶ **Mountable from the top**
- ▶ For all common used roundslot cylinder e.g. Festo, SMC
- ▶ Plastic housing with clamping screw
- ▶ Connection cable or connector on cable
- ▶ Enclosure rating IP 67
- ▶ LED status indicator

Accessories

Round connector

Connection diagram

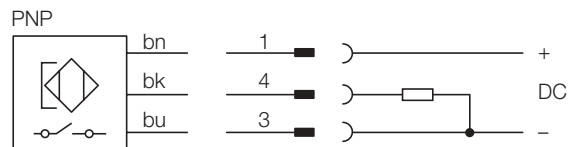



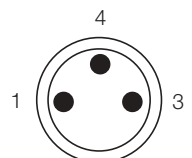

Wire colour	Contact	Assignment
bn brown	1	+ VDC
bk black	4	NO
bu blue	3	- VDC

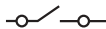

Electrical and mechanical data

Operating voltage U_b	10 ... 30 V DC	Short-circuit protected (pulsed)	yes
Ripple U_{pp}	$\leq 10\%$ of U_b	Reverse-polarity protected	yes
Voltage drop U_d	$\leq 2,5$ V DC	Enclosure rating to DIN 40050	IP 67
Power consumption (inactive)	≤ 8 mA	Shock and vibration stress	30 g, 11 ms
Continuous current I_a	≤ 70 mA	Ambient temperature T_a	10 to 55 Hz, 1 mm - 25 ... + 75 °C
Switching delay	≤ 0.1 ms	Housing material	PA
Hysteresis H typ.	≤ 1.5 mT	Connection cable 2 m	PUR 3 x 0.09 mm ²
Repeatability R	$\leq \pm 0.1$ mm	Connection cable with M8x1 mm	PUR
(U_b and T_a constant)			
EMC	to EN 60 947-5-2		

Selection table

Sensing face	Switching output	Output function	Switching frequency in Hz	Connection type	Type	Order number
	PNP		1000	Cable 2 m	MZN1-06VPS-KUO	1022053
	PNP		1000	Cable w. M 8 x 1 mm	MZN1-06VPS-KPO	1022054
	PNP		1000	500 mm Cable w. M 8 x 1 knurled screw	MZN1-06VPS-KRD	1023985

SICK

Great Britain
Erwin Sick Ltd.
Waldkirch House
39 Hedley Road, St. Albans
Hertfordshire AL 1 5BN
☎ +44 17 27-83 11 21
Fax +44 17 27-85 67 67
erwin@sick.co.uk

USA
SICK, Inc.
6900 West 110th Street
Bloomington, MN 55438
☎ +1 (952) 9 41-67 80
Fax +1 (952) 9 41-92 87
WATS: 1-800-325-7425
info@sickoptic.com

Australia
Erwin Sick Optic-Electronic
Pty. Ltd. Head Office, P.O. Box 214
899 Heidelberg Road
Ivanhoe, Vic. 3079, Australia
☎ +61 39 49 74 10 0
(0 08) 33 48 02 - toll free
Fax +61 39 49 71 18 7
sick@werple.net.au