

Operating scanning range
350 ... 3400 mm

Ultrasonic sensor

- High measurement accuracy thanks to time-of-flight measurement
- Independent of material shape (including films, glass and bottles)
- Teach-in
- Insensitive to dirt, dust and fog
- Operating scanning range up to 3,400 mm
- Binary outputs or analog output

Dimensional drawing

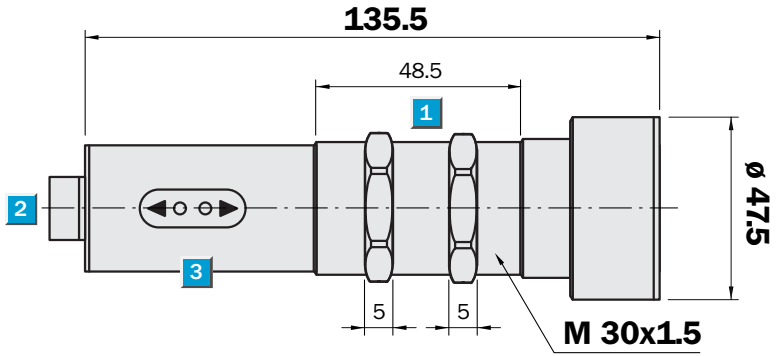

Adjustments possible

All types

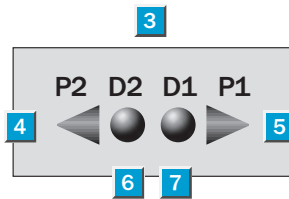

- 1 Fastening nuts, width across 36 mm
- 2 Connection plug M 12
- 3 Control and display panel
- 4 Setting key 2
- 5 Setting key 1
- 6 2
- 7 1

Connection types

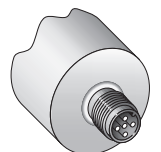
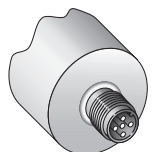
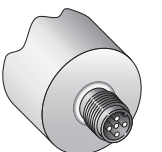

5-pin, M 12

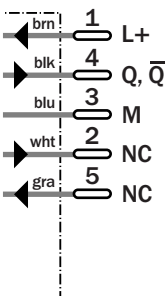

5-pin, M 12

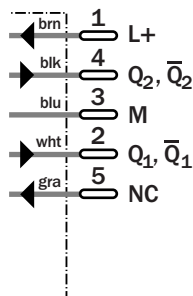

5-pin, M 12

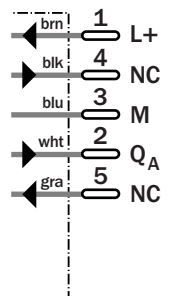

Accessories

Mounting systems

Technical data	UM 30-	14111	14112	14113							
-----------------------	--------	-------	-------	-------	--	--	--	--	--	--	--

Operating scanning range

(limiting scanning range)	350 ... 3400 mm (5000)			
Ultrasonic frequency	120 kHz			
Resolution	1 mm			
Reproducibility	± 0.15 % of final value			
Accuracy	≤ 2 % of final value			
Supply voltage V_S	12 ... 30 V DC ¹⁾			
Ripple	± 10 %			
Current consumption ²⁾	≤ 70 mA			
Switching outputs, reversible³⁾	Q: 1 x PNP, $V_S - 2 V$, $I_{max} = 500 mA$			
	Q_1, Q_2 : 2 x PNP, $V_S - 2 V$, $I_{max} = 500 mA$			
Analog output, reversible ^{3) 4)}	Q_A : 4 ... 20 mA/0 ... 10 V			
Response time ⁵⁾	180 ms			
Switching frequency	3/s			
Switching hysteresis	50 mm			
Standby delay	2 s			
Connection type	Plug M 12, 5-pin			
Enclosure rating	IP 65			
Ambient temperature ⁶⁾	Operation -20 °C ... +70 °C			
	Storage -40 °C ... +85 °C			
Weight	310 g			
Housing material	Nickel-plated brass			

- 1) Limit values
- 2) Without load
- 3) Outputs short-circuit protected

4) Automatic switching between voltage and current outputs dependent on load

Current output 4 ... 20 mA:
 $R_L \leq 500 \Omega$, $V_S \geq 20 V$;
 $R_L \leq 100 \Omega$, $V_S \geq 12 V$
 Voltage output 0 ... 10 V:
 $R_L \geq 100 k\Omega$; $V_S > 15 V$

- 5) Only with UM 30-____3: Recovery time according to EMV EN 50 319
- 6) Temperature compensation at -20 ... +50 °C

Detection ranges

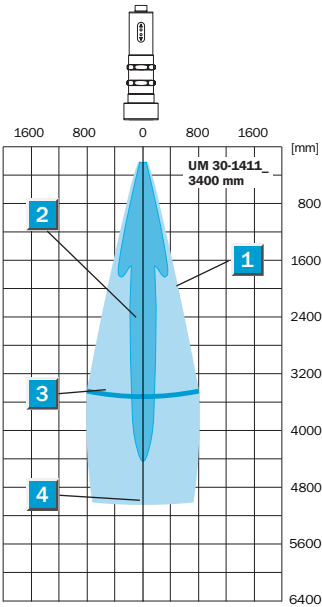

1	Aligned plate 500 x 500 mm
2	Pipe diameter 27 mm
3	Operating scanning range
4	Limiting scanning range

Order information

Type	Part no.
UM 30-14111	6 025 658
UM 30-14112	6 025 663
UM 30-14113	6 025 668